

# PIPER

The Food-Focused Equipment Company

## REFRIGERATED DROP-INS

(2-6)BCM-DI

Installation and Operating Manual



**For service information call 800-544-3057**

Please have the following information available before calling. Information can be found on the identification/certification tag:

- Model Number
- Serial Number
- Date of Purchase
- Part Description and number as shown in parts list



**IMPORTANT INFORMATION  
READ BEFORE USE**

This manual contains important safety information concerning the maintenance, use and operation of this product. Failure to follow these instructions could result in damaging equipment, voiding the warranty, serious injury or even death.

Piper Products, Inc  
300 South 84th Avenue  
Wausau, WI 54401

Phone: 715-842-2724 . FAX: 715-842-3125

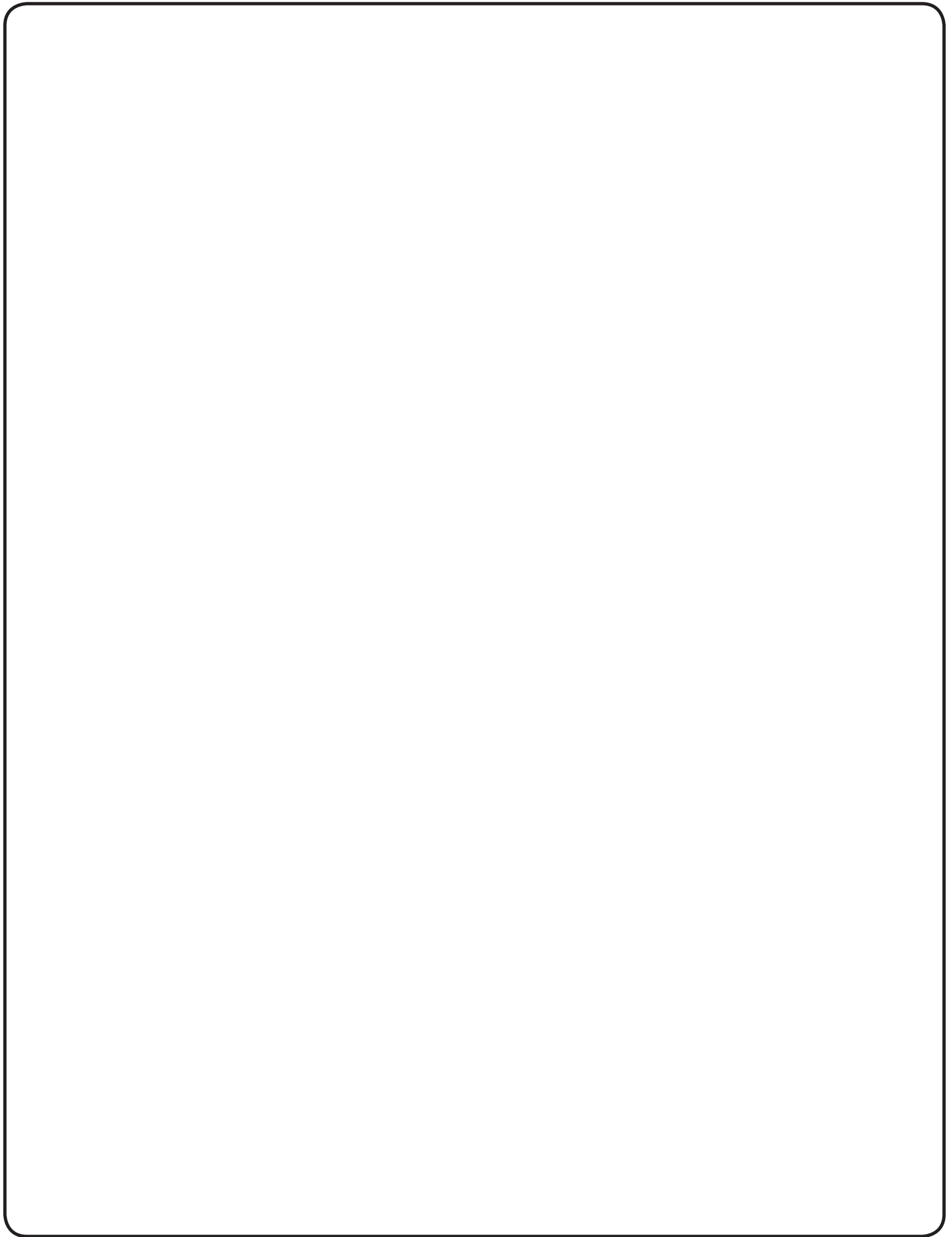

# TABLE OF CONTENTS

2	INTRODUCTION
2	FREIGHT DAMAGE CLAIMS
3	INSTALLATION
4	COUNTER CUTOUT DIMENSIONS
5	AIRFLOW REQUIREMENTS
5	THEORY OF OPERATION
6	START-UP AND OPERATION
6	THERMOSTAT SETTINGS
7	MAINTENANCE
8	GENERAL CLEANING
8	CLEANING CONDENSER UNIT
9	TROUBLESHOOTING GUIDE
10	BCM-DI EXPLODED VIEW
11	WIRING DIAGRAM
12	WARRANTY

## INTRODUCTION

Congratulations! You have just purchased one of the finest pieces of equipment on the market today. Before installing or operating your new Piper equipment, you should read through this manual. This manual should be retained for further reference as it contains installation and operating instructions, service tips, part lists and warranty information.

**For your safety, read and follow all cautions and warnings.**

## FREIGHT DAMAGE CLAIMS

Your Piper equipment was carefully inspected and packed before leaving our factory. The transportation company assumes full responsibility for safe delivery of this equipment. Piper Products cannot assume responsibilities for damage or loss incurred in transit. Visible damage or loss should be noted on the freight bill and signed by the person making the delivery.

A freight claim should be filed immediately with the transportation company. If damage is unnoticed or concealed until equipment is unpacked, notify the transportation company immediately and tell them you want to file a concealed damage claim. This must be done within ten (10) days after delivery was made. Be sure to retain all packing material and cartons.

### WARNING

Installation of this equipment should be done only by persons qualified or licensed to install electrical equipment.

Adjustments and service work should be performed only by a qualified service technician. Service is available through Authorized Piper Parts and Service Distributors throughout the United States. For a complete listing of these call or write Piper Products, Inc. for the name of the nearest distributor.

This equipment is intended for commercial use only. Not for household use. Use of other than genuine Piper replacement parts or service work performed by other than an authorized Piper service agent will void the warranty.

Do not use any corrosive cleaners. Piper only approves soap and water for cleaning stainless steel.

# INSTALLATION



## ELECTRICAL CONNECTION

**WARNING!!!! DO NOT USE EXTENSION CORDS (VOIDS WARRANTY)**

### Ground:

The electrical outlet must be provided with an efficient ground, and the voltage and the frequency of the electrical line matches those indicated on the data plate.



If unsure about the efficiency of the ground, have your electrical circuit checked by a qualified technician.

### Supply Voltage:

When the cooler is operating check that the supply voltage is not dropping or increasing under/over +10% the rated voltage (98 Volts to 127 Volts) or (198 Volts to 243 Volts).



**The manufacturer is not responsible for damages or accidents arising from the misuse or disregard of electrical connections.**

### Outside Storage: ATTENTION!

- The cooler is not designed for outdoor use.
- The cooler should not be stored outside in direct sun or rain.

### Ambient (Environmental) Conditions:

- Only locate the cooler in a maximum condition of 80°F (27°C) and 60% relative humidity.

### Positioning

- Keep away from heat sources, such as radiators or air conditioning pipes.
- The ambient temperature must not be higher than 80°F (27°C).

### Cooler Leveling:

- To provide the best performance the cooler must remain level.

## COUNTER CUTOUT DIMENSIONS

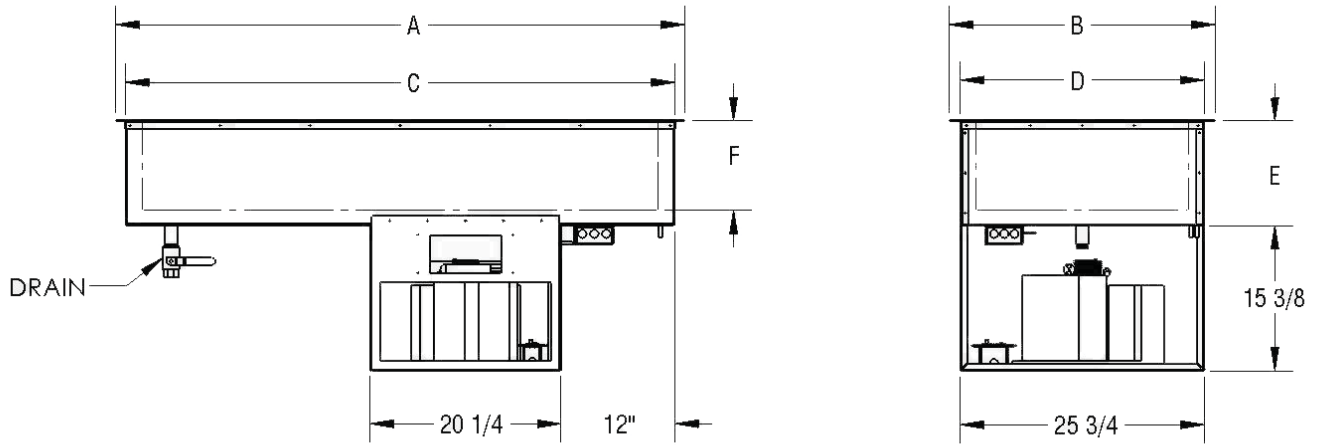

Type	Cutout Dimensions	(A)	(B)	(C)	(D)	(E)	Well Depth (F)	BCM
								Part #
2-Well	30-5/8" x 26"	32"	28"	30"	25-3/4"	11"	9-7/16"	2BCM-DI
3-Well	44-5/8" x 26"	46"	28"	44"	25-3/4"	11"	9-7/16"	3BCM-DI
4-Well	58-5/8" x 26"	60"	28"	58"	25-3/4"	11"	9-7/16"	4BCM-DI
5-Well	72-5/8" x 26"	74"	28"	72"	25-3/4"	11"	9-7/16"	5BCM-DI
6-Well	86-5/8" x 26"	88"	28"	86"	25-3/4"	11"	9-7/16"	6BCM-DI

NOTE: Control cutout is 2-1/4"W x 4" H

## AIRFLOW REQUIREMENTS

Drop-in units are designed for customer specific installations. During installation, ventilation must be provided at each end of the condenser to properly cool the refrigeration system. A minimum vent space of 90 square inches per grill is required. Two grills are required - one for incoming air, and another for the exhaust air. Failing to provide proper ventilation will void the warranty.

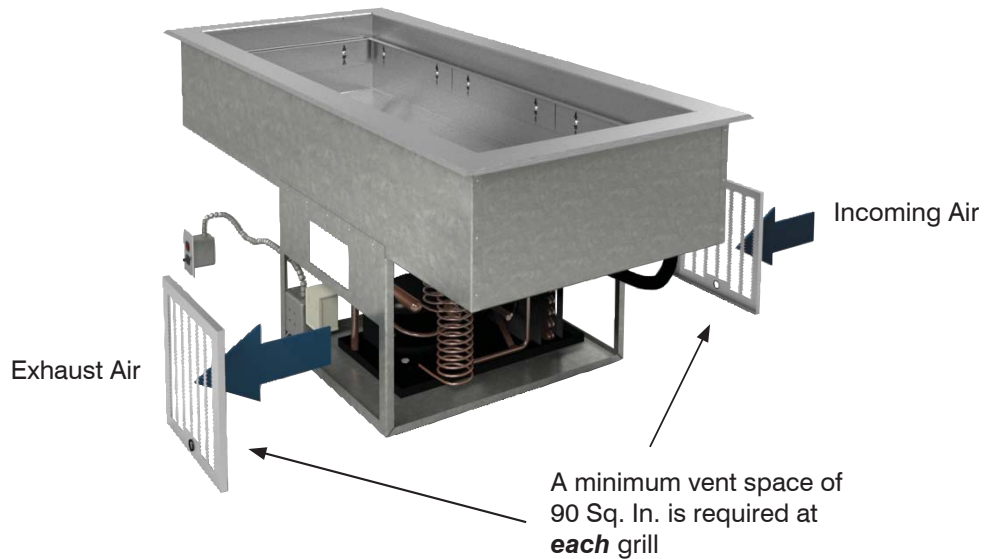

## THEORY OF OPERATION

The Mechanically Refrigerated Bloomington Cold Food Drop-in (BCM-DI) is designed to be used without ice and meet NSF 7 classification to display cold foods and salads during the meal period. The mechanical refrigeration system uses a 1/3 horsepower compressor and thermostat control to provide cooling to copper coils mounted to the sides of the food well. Crushed ice should be used along with the mechanical refrigeration system to achieve the optimum control of food temperatures over longer periods of time.



**NOTE:** Cold Food Drop-ins are NOT refrigerators and will NOT keep food cold for long periods of time. Food should always be placed into the drop-in directly from the refrigerator. When the food in the drop-in reaches a temperature of 38° to 40° Fahrenheit; it should be placed back into the refrigerator and replaced with cold food from the refrigerator.

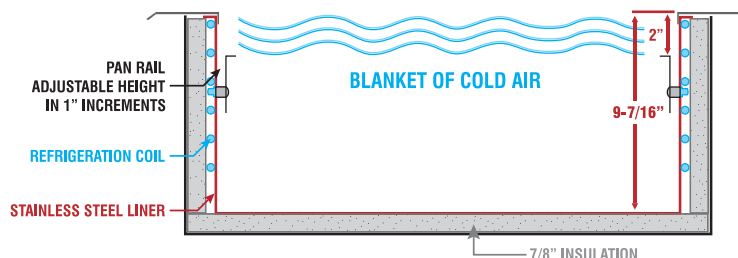

# START-UP AND OPERATION

## OPERATING THE COOLER

### Before Operating the Cooler

- Ensure that the electrical outlet is connected effectively to earth (ground), suitable to provide the voltage indicated on the data plate.
- Ensure proper air flow to the front rear and sides.
- Ensure the cooler is level.

**Electrical Service Switch:** Turn the control panel switch to the “ON” position.

- The pilot light will light and the condensing unit will start.
- Note: After 30min (+/-) the bottom of the cold pan should be cold to the touch and start to frost over.

### Energy Savings / Product Performance Location Tips:

- When possible, DO NOT place the cooler near air conditioning vents or returns.
- When possible, place the cooler the maximum distance from the exit or entrance door.

## THERMOSTAT SETTINGS

### TEMPERATURE CONTROL:

- **Setting:** (Factory set) Temperature control is set at 25°F with a 12 degree differential.
- **Defrost:** Defrost is not installed in this unit and the unit needs to be turned off after service.
- **Changes in the Settings:** Adjustments to the settings may be needed but shouldn't be set below 13°F for temperature with a 12 degree differential. If you are below this range damage may occur to the controller and will need to be replaced.

Note: With 25°F for temperature and 12 degree differential, the cut in will be 25°F and the cut out will be 13°F.



## MAINTENANCE

To obtain the best performance from your equipment, it should be cleaned daily and maintained in good condition.



### SAFETY / ENVIRONMENTAL CAUTION

#### PERSONAL PROTECTION:

Check your company safety and environmental policy before cleaning or servicing.



**Safety Tip!** : Utilize protective gloves and safety glasses

#### ELECTRICAL POWER:



Before performing EXTENDED CLEANING where electrical components can become wetted, the power switch must be turned to OFF and the unit disconnected from the power source.



**WARNING:** Do not use any chlorinated or highly caustic cleaners, acids, ammonia or other corrosive cleaners. These may cause corrosion and/or damage to the stainless steel. Piper only approves soap and water for cleaning stainless steel. Do not allow water to stand in wells for long periods of time. Well must be emptied and cleaned after every serving period.

#### REQUIRED MONTHLY MAINTENANCE:

- Check that the condenser fan works properly
- Check thermostat settings
- Check operating temperature of unit
- Clean entire refrigerated case
- Clean condenser coils
- Check and clean drainage lines
- Check electrical connection

## GENERAL CLEANING

### Stainless Steel and Aluminum:

- Piper only approves soap and water for cleaning stainless steel.
- **NOTICE: Do NOT use chlorinated cleaners.**

### General Surfaces, Fiberglass:

- Clean surfaces with a soft cloth or sponge utilizing a mild detergent. Rinse completely with warm water and then dry.
- **NOTICE: Do NOT use steel wool**

### Hardened Foods or Scale Deposits:

- Clean hardened foods or scale deposits by utilizing a plastic scouring pad and a mild detergent. Rinse completely with warm water and dry.
- **NOTICE: Do NOT use steel wool**

## CLEANING CONDENSING UNIT

**NOTICE: FAILURE TO PROPERLY CLEAN THE CONDENSER WILL VOID THE WARRANTY**

**Monthly** cleaning of the condensing unit is essential for product temperature and refrigeration system performance.

### Cleaning Method:

- **WARNING:** Disconnect electrical power to the cooler by turning master switch to the “OFF” position and unplugging cooler from electrical receptacle
- Remove the louvered panels from the condensing unit compartment.
- Clean condenser by using a brush and vacuum cleaner to remove all dust and dirt.

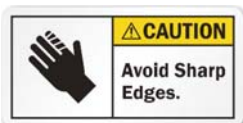

**CAUTION:** The fins on the condensing unit coils are sharp!  
Safety Tip! : Utilize protective gloves and safety glasses



**WARNING:** Refrigerant is under high pressure. Do NOT bend, kink or damage any tubing or condensing unit coil.

## TROUBLESHOOTING GUIDE

If problems are not found by the following checks, then you should contact your Authorized Parts and Service Dealer for service. They have the necessary parts and training to repair your unit quickly and efficiently.



**DANGER:** Disconnect all power to unit before servicing.

SYMPTOMS	POSSIBLE CAUSE	REMEDIES
Pilot light is off and condensing unit does not run	No electrical supply	Is the unit plugged in?
		Check circuit breaker and fuse.
		Check switch on control panel is in "ON" position.
Pilot light is on but condensing unit does not run	Thermostat control	Is the thermostat set properly?
Unit does not cool to proper temperature	Ducting	Are there heating or A/C ducts, make-up air ducts or fans causing cool drafts?
	Not pre-cooled	Has the unit been allowed to pre-cool for at least 45 minutes with lids on?
	Thermostat control	Is the thermostat set properly?
	Voltage	Call a service technician.
Does not maintain temperature	Air flow	Check condenser coils for proper air flow.
	Ducting	Are there heating or A/C ducts, make-up air ducts or fans causing cool drafts?
	Not pre-cooled	Has the unit been allowed to pre-cool for at least 30 minutes?
	Thermostat control	Is the thermostat set properly?
	Voltage	Call a service technician.
	Ice Buildup	If ice buildup is over 1/8" thick turn unit off. Clean water out and restart unit.

**Call Piper Products directly at 800-544-3057 if you need further assistance.**

# BCM-DI PARTS BREAKDOWN

ITEM NO.	PART NUMBER	DESCRIPTION	QTY
1	0112900	CONDENSER: 1/3HP LO 134A 120V	1
2	0112083	ACCUMULATOR - 5.8 CU IN 3/8 ODF	1
3	0026900	BOX - 4S 1/2 SQUARE 1-1/2 DEEP	1
4	0092650	COVER - 88465 4-SQ FLAT BOX	1
5	0112143	DRIER - REFRIG .187 X .09 ODF	1
6	0112037	THERMOSTAT - RANCO 010-1416	1
7	0112144	TUBE - CAPILLARY 040 X 120 X 087	1
8	0375725	VALVE - 1" CM	1
9	0112174	VALVE - SERVICE 3/8ODF TEE	1
10	0860855-001	CAGE - CMDI	1
11	0243752	AC SWITCH WITH RED LIGHT	1
12	0241450	PLATE - RECEPTICLE COVER	1
13	0243754	ELECTRICAL BOX WITH EARS - FLUSH MOUNTED	1

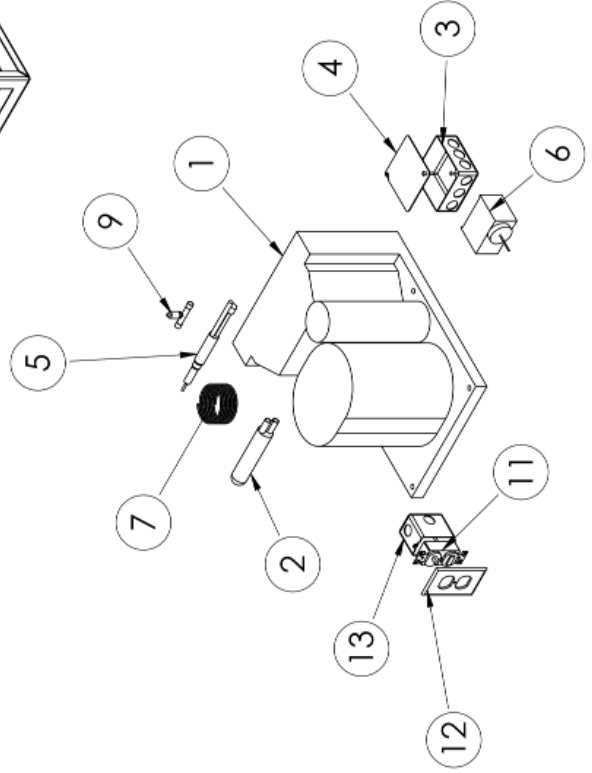
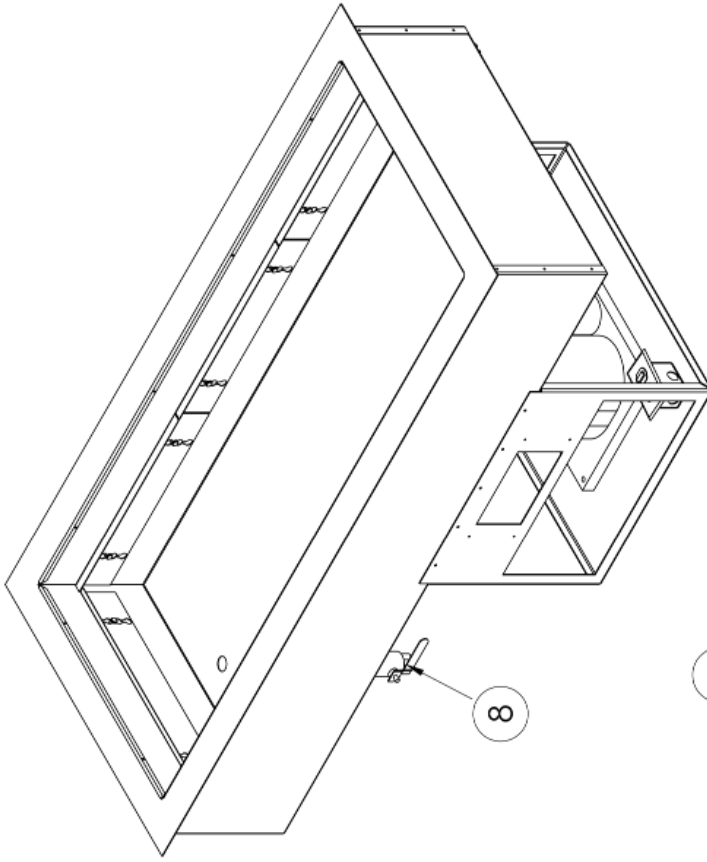

# BCM-DI WIRING DIAGRAM

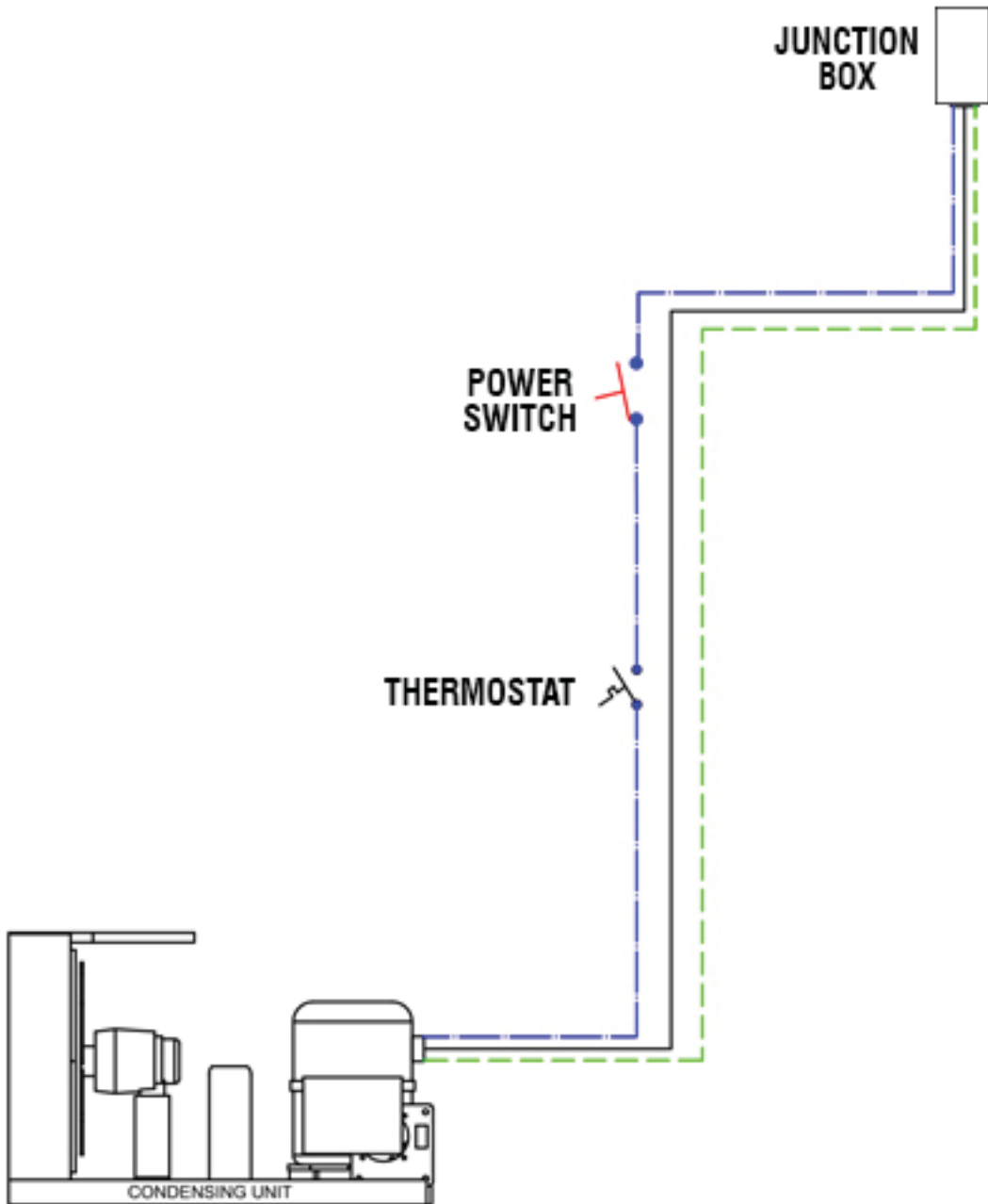

## PIPER PRODUCTS, INC. LIMITED WARRANTY

Piper Products, Inc. warrants to the original purchaser that its equipment will be free from defects in the materials and/or parts for a period of 12 months from date of shipment and reported to the factory.

The purchaser is responsible for having equipment properly installed, operated under normal conditions with proper supervision and to perform periodic preventative maintenance. Equipment failures caused by inadequate water quality, improper cleaning, harsh chemicals, or acids are not covered under warranty.

The manufacturer's obligation under this warranty shall be the replacement or repair of defective parts within the warranty period. Excessive labor (more than 1/2 hour) required to access Piper equipment built into cabinets, tables or structures by others, is NOT covered under labor warranty. Example: Piper multiple- or single-well food wells. All labor shall be performed during regular working hours. Overtime premium will be charged to buyer. After thorough examination, the decision of the Piper Products Service Department shall be final.

Any defective parts to be repaired or replaced must be returned to Piper Products, Inc., 300 South 84th Avenue, Wausau, WI 54401, transportation charges prepaid, and they must be properly packed and tagged. The serial and model number of the equipment and date of original installation of such equipment must be given. However, after one year we will not assume any responsibility for any expenses (including labor) incurred in the field incidental to the repair or replacement of equipment covered by this warranty. Our obligation hereunder to repair or replace a defective part is the exclusive remedy for breach of this warranty; and we will not be liable for any other damages or claims, including consequential damages.

If, upon inspection by Piper Products, Inc. or its Authorized Service Agency, it is determined that this equipment has not been properly installed or has not been used in an appropriate manner, has been modified, has not been properly maintained, the warranty will be void. Also, if the nameplate or other identifying marks have been removed, defaced or changed or the unit has been repaired or altered by persons other than expressly approved by Piper Products, Inc., the warranty will be void. If the equipment has been subjected to misuse or misapplication, neglect, abuse, accident, damage during transit or delivery, fire, flood, riot or acts of God, then this warranty shall also be void. When any situation occurs which voids the warranty the manufacturer shall not be liable for any damage to any person or any property which may result from the use of the equipment thereafter.

Warranty is limited to Piper manufactured products only and does not apply to other equipment which may be connected to or installed within.

No representative, dealer, distributor or any other person is authorized or permitted to make any other warranty or obligate Piper Products, Inc. to any liability not strictly in accordance with this policy.

This warranty is in lieu of all other warranties expressed or implied, including any warranty of merchantability, and fitness for a particular purpose. Piper Products does hereby exclude and shall not be liable to purchaser for any consequential or incidental damages including but not limited to damages to property, damages for loss of use, loss of time, loss of profits or income, resulting from any breach of warranty.

## NOTES

# **PIPER**

The Food-Focused Equipment Company

Piper Products, Inc  
300 South 84th Avenue  
Wausau, WI 54401  
Phone: 715-842-2724 . FAX: 715-842-3125